



EUROPEAN ANTENNAS



SECTOR ANTENNA

MODEL: SA11-18R-702/340

FREQUENCY: 1.71 – 1.88GHz	GAIN: 10 dBiC
POLARISATION: R.H. Circular	BEAMWIDTH: 70° (azimuth) x 30° (elevation)
AXIAL RATIO: 3 dB Typical	VSWR: 1.5 : 1 Max
POWER RATING: 20 W	FRONT TO BACK: > 25 dB
TEMPERATURE: -20°C to +50°C	MASS: 0.65 Kg/1.43lbs
RADOME: Grey Moulded Polymer	WIND LOADING: 9.0Kg/19.9lbs @100mph

PLAN VIEW

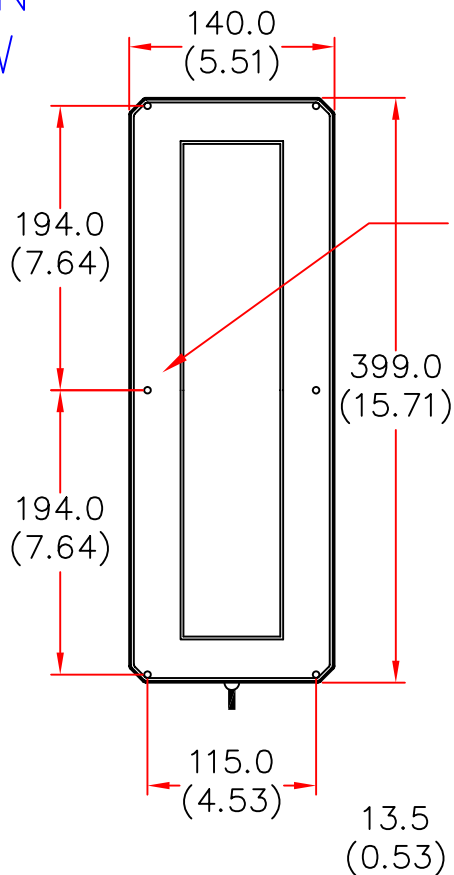

ISOMETRIC VIEW

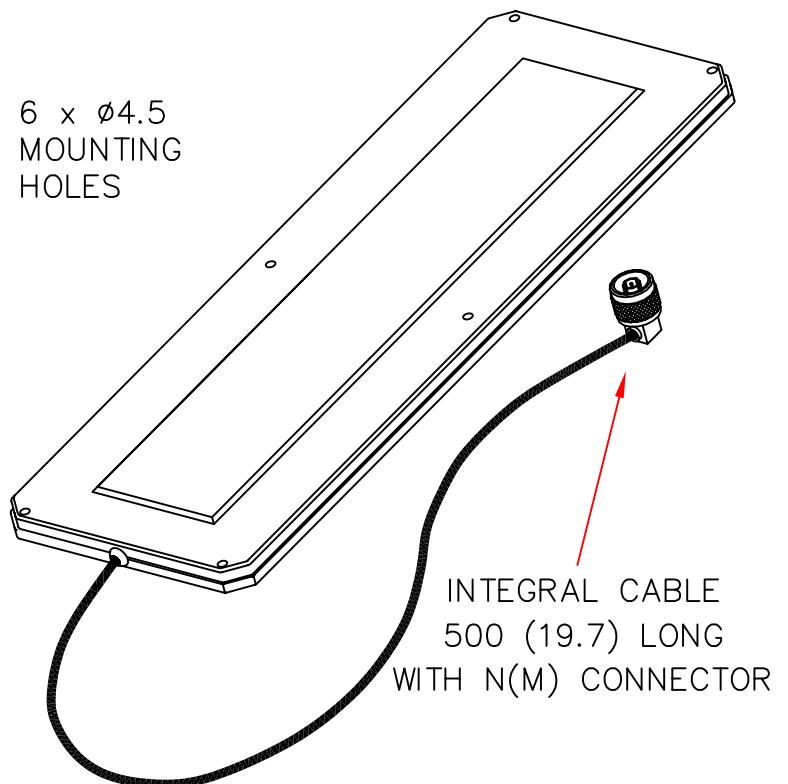

END VIEW

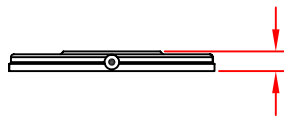

DIMENSIONS: mm (inches)

GA 340-1 Issued 011098

EUROPEAN ANTENNAS LTD.

TEL: +44 (0)1638 731888

LAMBDA HOUSE, CHEVELEY,
NEWMARKET, SUFFOLK, CB8 9RG,
UNITED KINGDOM.

FAX: +44 (0)1638 731999

European Antennas Ltd. has a policy of continuous development and therefore stress that the data contained on this sheet should be used for guidance only.