



# EUROPEAN ANTENNAS



## MULTI-SECTOR ANTENNA

MODEL: SA10-HEX-130V/267

FREQUENCY: 12.7 – 13.5 GHz	GAIN: 10 dBi (each sector)
POLARISATION: Linear (Vertical)	BEAMWIDTH: 80°(Az.) x 40°(El)
CROSS POLAR: 20 dB Typical	VSWR: 1.5 : 1
POWER RATING: 5 W	FRONT TO BACK: 20 dB
TEMPERATURE: -20°C to +50°C	MASS: 150 g
RADOME: Glass Fibre/Matt Black	WIND LOADING: N/A

### PLAN VIEW

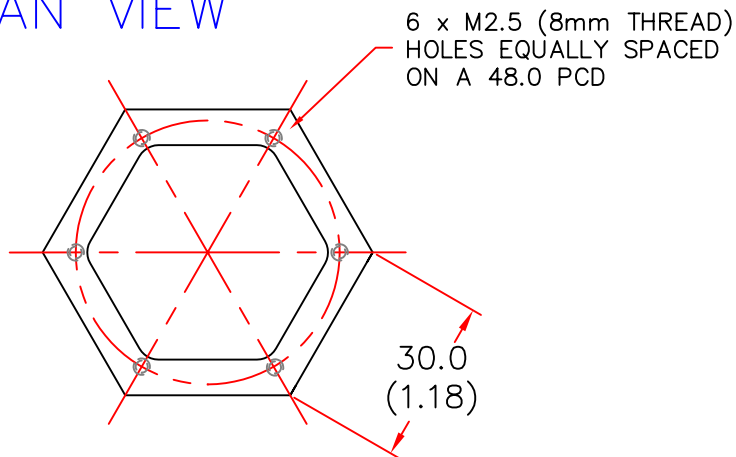

### ISOMETRIC VIEW

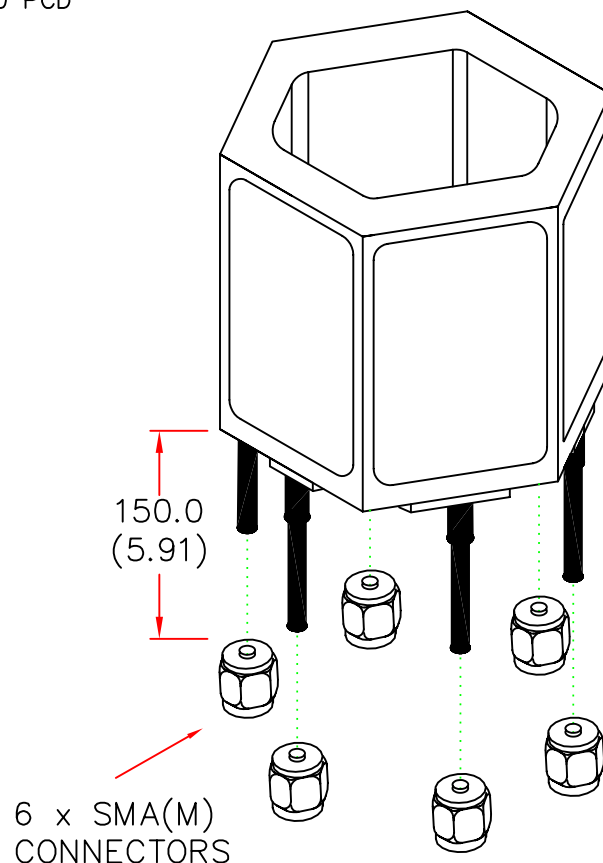

### SIDE VIEW

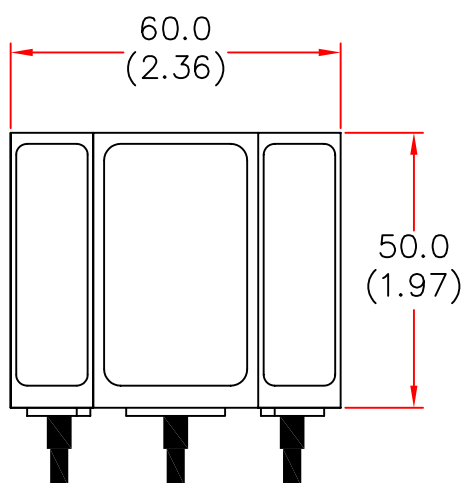

DIMENSIONS: mm (inches)

GA 267-2 Issued 111200

EUROPEAN ANTENNAS LTD.

TEL: +44 (0)1638 731888

LAMBDA HOUSE, CHEVELEY,  
NEWMARKET, SUFFOLK, CB8 9RG,  
UNITED KINGDOM.

FAX: +44 (0)1638 731999

European Antennas Ltd. has a policy of continuous development and therefore stress that the data contained on this sheet should be used for guidance only.