



EUROPEAN ANTENNAS



VERTICALLY POLARISED OMNI ANTENNA

MODEL: VOA4-3900/130

FREQUENCY: 3.75 - 4.05 GHz	GAIN: 4 dBi
POLARISATION: Linear (Vertical)	BEAMWIDTH: 360° x 40°
CROSS POLAR: 20 dB Typical	VSWR: 1.5 : 1
POWER RATING: 50 W	FRONT TO BACK: N/A
TEMPERATURE: -40°C to +60°C	MASS: 0.3 Kg/0.7 lbs
RADOME: Glass fibre (Gloss White)	WIND LOADING: 1.1Kg/2.4lbs @100mph

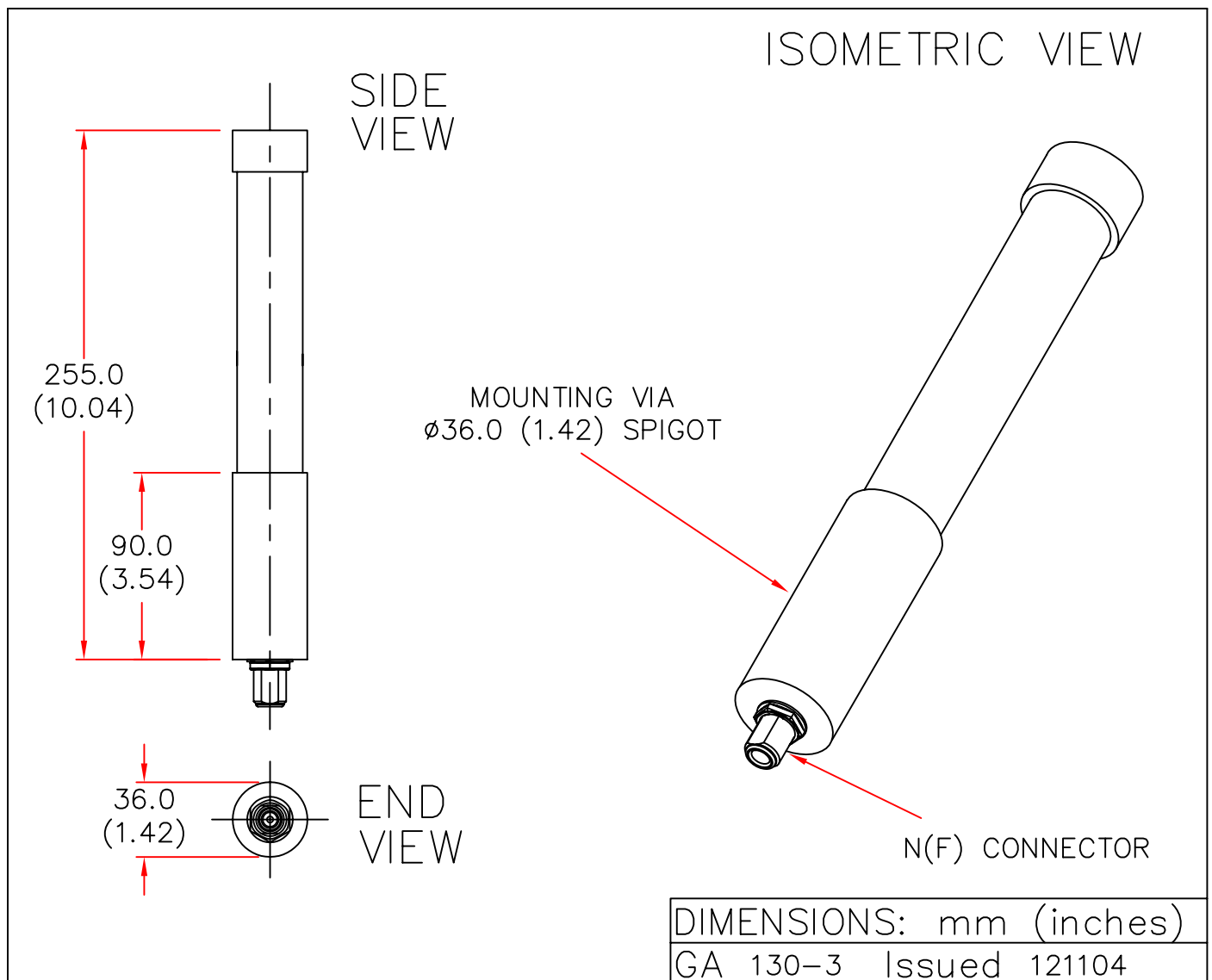

EUROPEAN ANTENNAS LTD.

TEL: +44 (0)1638 731888

LAMBDA HOUSE, CHEVELEY,
NEWMARKET, SUFFOLK, CB8 9RG,
UNITED KINGDOM.

FAX: +44 (0)1638 731999

European Antennas Ltd. has a policy of continuous development and therefore stress that the data contained on this sheet should be used for guidance only.