



EUROPEAN ANTENNAS

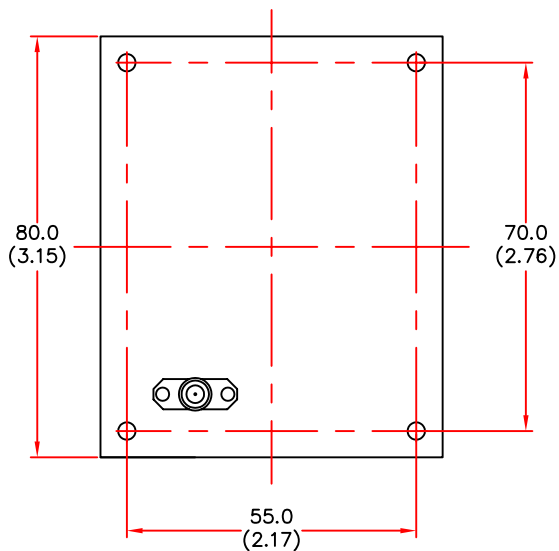

PLATE ANTENNA

MODEL: PA5-2460R/133

FREQUENCY: 2.46 GHz (\pm 20 MHz)	GAIN: 5 dBiC
POLARISATION: R.H. Circular	BEAMWIDTH: 100° x 100°
AXIAL RATIO: 3dB at F_0	VSWR: 2 : 1
POWER RATING: 10 W	FRONT TO BACK: 14 dB
TEMPERATURE: -20°C to +50°C	MASS: 100 g
FINISH: Matt Black	WIND LOADING: N/A

PLAN VIEW



ISOMETRIC VIEW

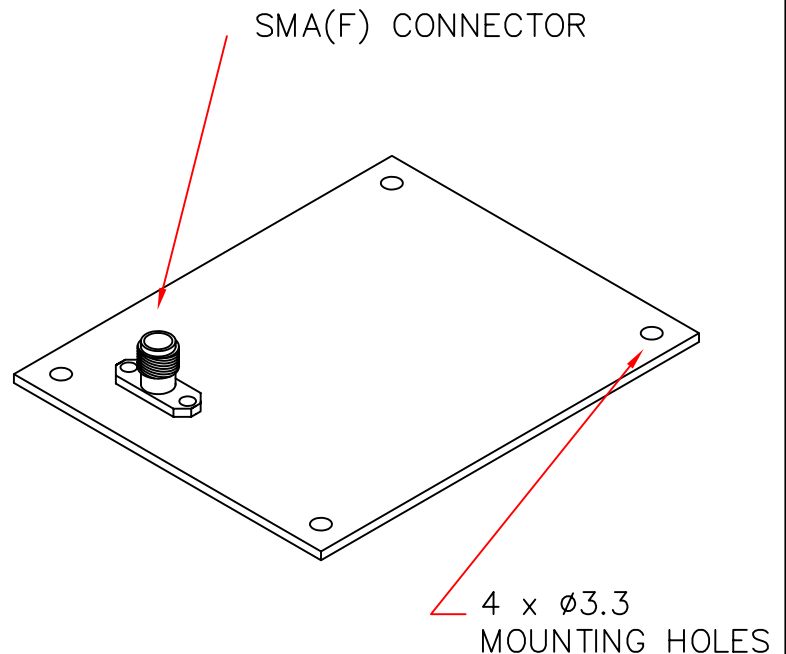

SIDE VIEW

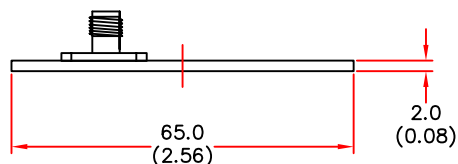

DIMENSIONS: mm (inches)

GA 133-1 Issued 031298

EUROPEAN ANTENNAS LTD.

TEL: +44 (0)1638 731888

LAMBDA HOUSE, CHEVELEY,
NEWMARKET, SUFFOLK, CB8 9RG,
UNITED KINGDOM.

FAX: +44 (0)1638 731999

European Antennas Ltd. has a policy of continuous development and therefore stress that the data contained on this sheet should be used for guidance only.